

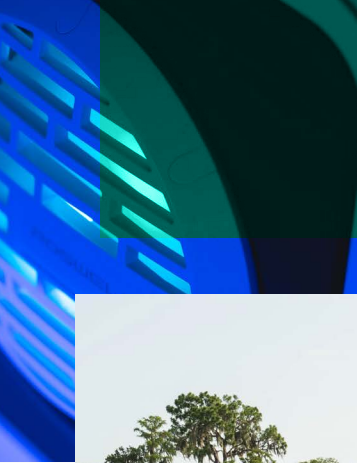

R
ROSWELL.[®]
MARINE

2025 AFTERMARKET
CATALOG





PASSION

HAS DRIVEN EVERY STEP OF THE ROSWELL MISSION TO DELIVER AWARD-WINNING PRODUCTS THAT REDEFINE YOUR MOMENTS ON THE WATER.

The origination of every Roswell product is a moment on the water that we believed could be made even better.

Each new design is driven by the same passion people around the world chase to lakes, rivers, and oceans to create experiences that define them.

Those experiences have inspired over 25 years of innovation, forming our DNA out of a vision that has seen humble beginnings become something so much more than the products we build.

Roswell is a movement that marches forward without compromise to make every second on the water unforgettable.





Remaining on the leading edge of marine audio, towers, racks, and accessories, Roswell Marine's innovation reaches beyond the famed design and engineering approach that has changed the way we experience our time on the water. With over 25 years in the game, a freethinking culture has developed the unique signature felt from the minute you walk in the building through every surface leading to the manufacturing floor where the latest bit of magic can be found.

Located in Rockledge, FL, Roswell's world-headquarters is home to the heart of concept-to-completion product development and production with a modular, forward-thinking design focused on growth. Rapid prototyping and high-capacity product fulfilment provides the world's elite boat builders with confidence in the ability to maintain their march on the edge of innovation.



ROSWELL.
MARINE

- OEM PARTNERS -

NAUTIQUE

CENTURION

SUPREME

MOOMBA



OCEANWORX

COBALT BOATS



FOREST RIVER



INNOVATION IS IN OUR DNA





WHERE IMAGINATION MEETS SOUND

MARINE TOWER SPEAKERS | MARINE SPEAKERS | MARINE SUBWOOFERS | MARINE AMPLIFIERS | MARINE AUDIO ACCESSORIES

Revolutionizing the industry with a signature sound engineered for perfection on the water, you will find the **Roswell R1 Audio** line celebrated by enthusiasts and the world's top boat manufacturers in applications where unmatched clarity, power, durability, and style is demanded. Evolving beyond sound alone to define a culture of acoustic perfection, it has become a catalyst for new experiences.



The relentless pursuit of a combined passion for music and being on the water, the **Roswell R1 Audio** line is developed without boundaries, to create a category all its own and take you to a place where imagination meets sound.

R1 PRO TOWER SPEAKERS

Discover a new age of audio with the revolutionary, patented **Roswell R1 Pro Tower Speakers**. Featuring the world's first RGB LED light-permeable speaker housing, this award-winning innovation consumes your senses with unmatched acoustic clarity in a place where imagination meets sound. The R1 Pro is a mission accomplished in developing the flagship of the R1 Audio line to introduce an entirely new listening experience on the water.

Industry First: Patented integrated RGB LED illuminates speaker and translucent housing to create your desired visual atmosphere

Machined billet Roswell 360° 3 in Universal Clamp with 1.90 in, 2.375 in and 3 in adapters

Deutsch Wiring Harness included for water-tight connection and easy installation

Side-mounted 1 in Compression Tweeter with integrated protection circuit

Klippel® tested and certified to guarantee acoustic performance



★ Patented

SPECIFICATIONS

Continuous Power (RMS):	200 Watts
Peak Power (RMS):	400 Watts
Woofer Sensitivity:	95 dB @ 1W/1M
Tweeter Sensitivity:	103 dB @ 1W/1M
Freq. Response (+/- 1 dB):	60Hz - 20 kHz
Impedance:	4Ω

DIMENSIONS

Nominal Speaker Diameter:	8 in 20.32 cm
Nominal Tweeter Diameter:	1 in 2.54 cm
Total Width:	15.48 in 39.32 cm
Total Depth:	13.35 in 33.91 cm
Hanging Distance: (clamp center to lowest point)	12.25 in 31.12 cm

MARINE SPEAKERS

CONSUME YOUR SENSES

R1 | ROSWELL
MARINE AUDIO

R1 Tower Speakers



R1 PRO TOWER SPEAKER

C920-1910W (White Grille)
C920-1910 (Black Grille)

- Power: 200W RMS | 400W PEAK
- Speaker: 8" R1 Pro Woofer
- Tweeter: 1" R1 Pro HLCD Tweeter



R1 8" TOWER SPEAKER

C920-1710 (White Grille)
C920-1711 (Black Grille)

- Power: 100W RMS | 200W PEAK
- Speaker: 8" R1 Coaxial
- Tweeter: 1" Silk Dome



R1 FIREFLY TOWER SPEAKERS

C920-22080 (White Grille)
C920-22081 (Black Grille)

- Power: 80W RMS | 160W PEAK
- Speaker: 6.5" R1 Coaxial
- Tweeter: 1" Silk Dome



R1 VAMP SPINS

C920-1821 (6.5" x 6.5" Black Grille)
C920-1823 (8" x 6.5" Black Grille)

- Power: 160W RMS | 320W PEAK
- Speaker: 8" R1 Coaxial
- Speaker: 6.5" R1 Coaxial
- Tweeter: 1" Silk Dome

R1 PRO DUAL MOUNT ADAPTER

C927-22060



- Provides mounting solution for two sets of R1 Pro Tower Speakers.
- Compatible with all Nautique Telescoping Flight Control Towers.
- Machined from billet aluminum with anthracite finish.

R1 PRO TOWER SPEAKER COVERS

C920-21001



- UV-Stable neoprene material
- Anti-chafing velcro clasp
- Trailerable
- Machine washable

R1 8" TOWER SPEAKER COVERS

C920-21002



- UV-Stable neoprene material
- Anti-chafing velcro clasp
- Trailerable
- Machine washable

R1 Marine Speakers



R1 8" MARINE SPEAKERS

C920-1610 (White Grille)
C920-1611 (Black Grille)

- Power: 100W RMS | 200W PEAK
- Speaker: 8" R1 Coaxial
- Tweeter: 1" Silk Dome



R1 7.7" MARINE SPEAKERS

C920-21140 (White Grille)
C920-21145 (Black Grille)

- Power: 90W RMS | 180W PEAK
- Speaker: 7.7" R1 Coaxial
- Tweeter: 1" Silk Dome



R1 6.5" MARINE SPEAKERS

C920-1600 (White Grille)
C920-1601 (Black Grille)

- Power: 80W RMS | 160W PEAK
- Speaker: 6.5" R1 Coaxial
- Tweeter: 1" Silk Dome



R1 1" TWEETERS

C960-22030

- Power: 50W RMS | 100W PEAK
- 316 Stainless Steel mesh grille
- Inline 12 dB/oct crossover
- Speaker: 1" R1 Silk Dome Tweeter
- Can be angled up to 10° within mounting cup

R1 Specifications

- Integrated RGB LED backlit grille helps to create your desired visual atmosphere
- Klippel® tested and certified to guarantee acoustic performance
- Deutsch wiring harness included for water-tight connection
- Coaxially mounted 1in silk dome tweeter

- Concealed integrated 12 dB/oct crossover network
- Locking trim ring conceals all mounting hardware
- 2-Year Warranty
- Extreme saltwater and UV resistance

MARINE SUBWOOFERS

RESONATING YOUR CORE

R1 | ROSWELL
MARINE AUDIO

R1 Subwoofers



R1 12"
C920-1810 (White Grill)

- **Power:** 500W RMS | 1,000W PEAK
- **(R1 12")** Integrated RGB LED backlight the cone to create your desired visual atmosphere
- **(R1 12")** Press fit inserts hide installation hardware providing a clean finished look
- Dual 3 in voice coils
- Dual spider ensures linear excursion
- Integrated impedance switch allows you to easily select series or parallel voice coil configurations.
- Klippel® tested and certified to guarantee acoustic performance
- Klippel® optimized motor structure for maximum power handling and sound quality
- Custom machined wire terminals allow for rock-solid wire connections
- **Extreme salt and UV resistance**



R1 10"
C920-1800 (White Grill)
C920-1802 (Anthracite Grill)

- **Power:** 250W RMS | 500W PEAK
- **(R1 10")** Integrated RGB LED backlight the cone to create your desired visual atmosphere
- **(R1 10")** Press fit inserts hide installation hardware which provides a clean finished look
- Klippel® tested and certified to guarantee acoustic performance
- Klippel® optimized motor structure for maximum power handling and sound quality
- Custom machined wire terminals allow for rock-solid wire connections
- **Extreme salt and UV resistance**



R1 12" Sub Enclosure

C820-1815

- Made from marine grade materials
- Simple installation
- **Dimensions:** 16"W x 12"D x 20"H
- **Volume:** 1.3 ft3
- **Port Frequency:** 41 Hz



CENTURION R1 | Fi LOW PROFILE 12" PORTED SUBWOOFER ENCLOSURE

C820-25200

- Compatible with 2024 and newer Centurion R1 & Fi Boats
- Made from marine grade materials
- Simple installation
- **Dimensions:** 24.5" W x 9.9" D x 27.9" H
- **Volume:** 1.9 ft3
- **Port Frequency:** 32 Hz



R1 10" Sub Enclosure

C820-1805

- Made from marine grade materials
- Simple installation
- **Dimensions:** 13.5"W x 11.5"D x 18"H
- **Volume:** 1.1 ft3
- **Port Frequency:** 43 Hz



R1 SPEAKER TRIM RINGS

- **B720-1600GR** R1 6.5" Speaker Trim Ring - WHITE (EA)
- **B720-1601GR** R1 6.5" Speaker Trim Ring - BLACK (EA)
- **C720-21142** R1 7.7" Speaker Trim Ring - WHITE (EA)
- **C720-21147** R1 7.7" Speaker Trim Ring - BLACK (EA)
- **B720-1610GR** R1 8" Speaker Trim Ring - WHITE (EA)
- **B720-1611GR** R1 8" Speaker Trim Ring - BLACK (EA)

STACKABLE MARINE AMPLIFIERS

INNOVATIVE POWER FOR THE PINNACLE OF MARINE SOUND



R1 900.6 C920-1836SD

- Ch 1-6 calibrated crossover: **(FULL/HPF/LPF)**
- Bridgeable 6-channel design
- 2 Ohm Stable at 165 watts per channel
- Switchable Differential RCA inputs minimize interference and induced noise
- Conformal-coated PCBs and Nickel-plated wire terminals



R1 650.4 C920-1834SD

- Ch 1-4 calibrated crossover: **(FULL/HPF/LPF)**
- Bridgeable 4-channel design
- 2 Ohm Stable at 165 watts per channel
- Switchable Differential RCA inputs minimize interference and induced noise
- Conformal-coated PCBs and Nickel-plated wire terminals

R1 550.2 C920-1832SD

- Ch 1-2 calibrated crossover: **(FULL/HPF/LPF) + Subsonic**
- 2 Ohm Stable at 275 watts per channel
- Switchable differential RCA inputs minimize interference and induced noise
- Phase control
- Conformal-coated PCBs and Nickel-plated wire terminals



R1 1000.1 C920-1831SD

- Low-pass and subsonic filters (12 dB/OCT)
- Bass boost control (0-18 dB @ 45Hz)
- Full 0-180° phase control
- Switchable Differential RCA inputs minimize interference and induced noise
- Conformal-coated PCBs and Nickel-plated wire terminals



R1 OFFSET AMP SPACERS C920-22106



R1 AMP SPACERS C920-1830



Marine Speakers



R SERIES 7.7" MARINE SPEAKERS C920-1912 (Anthracite Grille)

- Power: 80W RMS | 160W PEAK
- Speaker: 7.7" R-Series Coaxial
- Tweeter: 3/4" Mylar



R SERIES 6.5" MARINE SPEAKERS C920-1902 (Anthracite Grille)

- Power: 60W RMS | 120W PEAK
- Speaker: 6.5" R-Series Coaxial
- Tweeter: 3/4" Mylar

Marine Subwoofers



RMA 12" C920-1811 (Black Grille)

- Power: 500W RMS | 1,000W PEAK
- Dual 3" voice coils
- Dual spider ensures linear excursion
- Integrated impedance switch allows you to easily select series or parallel voice coil configurations.
- Klippel® tested and certified to guarantee acoustic performance
- Klippel® optimized motor structure for maximum power handling and sound quality
- Custom machined wire terminals allow for rock-solid wire connections
- **Extreme salt and UV resistance**



RMA 10" C920-1801 (Black Grille)

- Power: 250W RMS | 500W PEAK
- Klippel® tested and certified to guarantee acoustic performance
- Klippel® optimized motor structure for maximum power handling and sound quality
- Custom machined wire terminals allow for rock-solid wire connections
- **Extreme salt and UV resistance**

Offroad Amplifiers

OFFROAD SD 500.1 COMPACT AMPLIFIER C920-21006

- Compact Design
- IP66 rated
- Conformal coated PCBs
- Switchable Differential RCA inputs
- RCA Line Out Passthrough
- Standard potentiometers
- 18 dB/oct Crossover Slope
- LPF/FLAT/HPF
- 8 AWG power/ground
- 16 AWG remote wire
- 12 AWG speaker wires



OFFROAD SD 600.4 COMPACT AMPLIFIER C920-21005

- Compact Design
- IP66 rated
- Conformal coated PCBs
- Switchable Differential RCA inputs
- RCA Line Out Passthrough
- Standard potentiometers
- 12 dB/oct Crossover Slopes
- LPF/FLAT/HPF
- 8 AWG power/ground
- 16 AWG remote wire
- 16 AWG speaker wires



AUDIO PACKAGES

YOUR COMPLETE ROSWELL SOUND SOLUTION

R1
PRO

MARINE AUDIO PACKAGE

C920-23120 (White Grille)
C920-23121 (Black Grille)

- (1) pr. R1 Pro Tower Speakers
- (1) R1 550.2 Amplifier
- (1) RGB Remote & Controller



R1 6.5" MARINE AUDIO PACKAGE

C920-2557 (Black Grill)
C920-2556 (White Grill)

- (2) pr. R1 6.5" Marine Speakers
- (1) R1 650.4 Amplifier
- (1) Cybox Bluetooth Receiver
- (1) RGB Remote & Controller
- (1) Dual Zone Volume Control
- (2) 2M 2 Channel RCA cable



R1 10" SUBWOOFER PACKAGE

C920-2558 (White Grill)
C920-2559 (Anthracite Grill)

- (1) R1 10" Subwoofer
- (1) R1 550.2 Amplifier



R SERIES 6.5" MARINE AUDIO PACKAGE

C920-2553 (Anthracite Grill)

- (2) pr. R 6.5" Marine Speakers
- (1) R1 650.4 Amplifier
- (1) Cybox Bluetooth Receiver
- (1) RGB Remote & Controller
- (1) Dual Zone Volume Control
- (2) 2M 2 Channel RCA cable



RMA 10" SUBWOOFER PACKAGE

C920-2552 (Black Grill)

- (1) RMA 10" Subwoofer
- (1) R1 550.2 Amplifier

POWER RATINGS

Marine Speakers

Speaker	Continuous Power (RMS Method)	Peak Power (RMS Method)	Sensitivity	Frequency Response (+/- 3 dB)	Impedance Ω
R1 1" Tweeter	50W	100W	90 dB @ 1W/1M	4.6 kHz - 24 kHz	4 Ω
R1 6.5"	80W	160W	90 dB @ 1W/1M	60 Hz - 20 kHz	4 Ω
R1 7.7"	90W	180W	90 dB @ 1W/1M	55 Hz - 20 kHz	4 Ω
R1 8"	100W	200W	90 dB @ 1W/1M	50 Hz - 20 kHz	4 Ω
R 6.5"	60W	120W	87 dB @ 1W/1M	69 Hz - 20 kHz	4 Ω
R 7.7"	80W	160W	88 dB @ 1W/1M	55 Hz - 20 kHz	4 Ω

Tower Speakers

Speaker	Continuous Power (RMS Method)	Peak Power (RMS Method)	Sensitivity	Frequency Response (+/- 3 dB)	Impedance Ω
R1 Pro	200W	400W	Woofer: 95 dB @ 1W/1M Tweeter: 103 dB @ 1W/1M	60 Hz - 20 kHz	4 Ω
R1 8"	100W	200W	90 dB @ 1W/1M	50 Hz - 20 kHz	4 Ω
R1 6.5" x 6.5" Vamp Spins	160W	320W	90 dB @ 1W/1M	60 Hz - 20kHz	2 Ω
R1 8" x 6.5" Vamp Spins	160W	320W	90 dB @ 1W/1M	50 Hz - 20 kHz	2 Ω
R 6.5"	60W	120W	87 dB @ 1W/1M	69 Hz - 20 kHz	4 Ω
R1 8" x 6.5" Vamp Spins	160W	320W	90 dB @ 1W/1M	50 Hz - 20 kHz	2 Ω
R1 FireFly	60W	120W	87 dB @ 1W/1M	69 Hz - 20 kHz	4 Ω

Marine Subwoofers

Speaker	Continuous Power (RMS Method)	Peak Power (RMS Method)	Sensitivity	Frequency Response (+/- 3 dB)	Impedance Ω
R1 10" Subwoofer	250W	500W	88 dB @ 1W/1M	35 Hz - 300 Hz	4 Ω
RMA 10" Subwoofer	250W	500W	88 dB @ 1W/1M	35 Hz - 300 Hz	4 Ω
R1 12" Subwoofer	500W	1,000W	88 dB @ 1W/1M	32 Hz - 250 Hz	Dual 4 Ω
RMA 12" Subwoofer	500W	1,000W	88 dB @ 1W/1M	32 Hz - 250 Hz	Dual 4 Ω

Marine Amplifiers

Amplifier	Continuous Power (RMS Method)	Input Sensitivity	HPF/LPF (High/Low Pass Filter)	Frequency Response (+/- 1 dB)	Bass EQ	Subsonic Filter	Phase Control
R1 900.6	100W x 6 @ 4 Ω 165W x 6 @ 2 Ω Bridged: 300W x 3 @ 4 Ω	0.2 - 10.0V	HPF/LPF: 30Hz - 300Hz	10 Hz - 25 kHz	0 ~18dB @ 45Hz	-	-
R1 650.4	100W x 4 @ 4 Ω 165W x 4 @ 2 Ω Bridged: 300W x 2 @ 4 Ω	0.2 - 10.0V	HPF/LPF: 30Hz - 300Hz	10 Hz - 25 kHz	0 ~18dB @ 45Hz	-	-
R1 550.2	165W x 2 @ 4 Ω 275W x 2 @ 2 Ω Bridged: 550W x 1 @ 4 Ω	0.2 - 10.0V	HPF/LPF: 30Hz - 300Hz	10 Hz - 25 kHz	0 ~18dB @ 45Hz	10Hz - 55 Hz	0-180°
R1 1000.1	400W x 1 @ 4 Ω 675W x 1 @ 2 Ω 1000W x 1 @ 1 Ω	0.2 - 10.0V	LPF: 30Hz - 300Hz	10 Hz - 400 Hz	0 ~18dB @ 45Hz	10Hz - 55 Hz	0-180°

SPEAKER & AMP DIMENSIONS

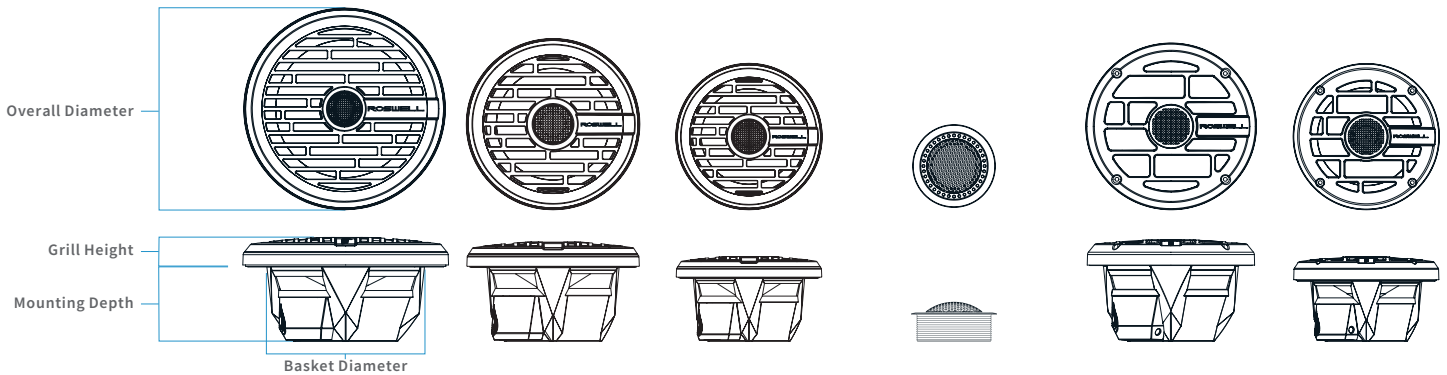

Marine Speakers						
	R1 8"	R1 7.7"	R1 6.5"	R 1" Tweeter	R 7.7"	R 6.5"
Nominal Diameter	8 in 20.32 cm	7.7 in 19.6 cm	6.5 in 16.51 cm	1.97 in 5 cm	7.7 in 19.56 cm	6.5 in 16.51 cm
Overall Diameter	9.21 in 23.4 cm	7.71 in 19.6 cm	6.81 in 17.3 cm	2.26 in 5.74 cm	7.72 in 19.61 cm	6.75 in 17.15 cm
Basket Diameter	3.325 in 8.45 cm	6.26 in 16.0 cm	5.25 in 13.35 cm	1.97 in 5 cm	6.26 in 15.9 cm	5.25 in 13.35 cm
Mounting Depth	3.325 in 8.45 cm	3.50 in 8.80 cm	3.00 in 7.60 cm	.75 in 1.9 cm	3.46 in 8.79 cm	3.00 in 7.60 cm
Grill Height	1.50 in 3.80 cm	1.20 in 3.00 cm	1.20 in 3.00 cm	.35 in .89 cm	1.22 in 3.10 cm	1.07 in 2.72 cm

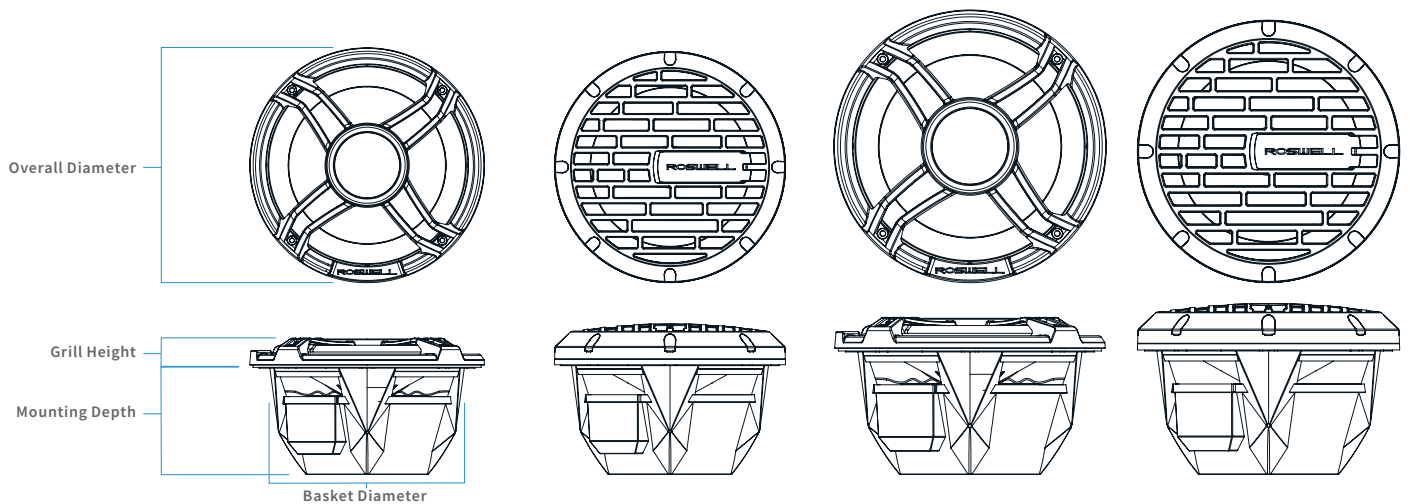

Marine Subwoofers				
	RMA 10"	R1 10"	RMA 12"	R1 12"
Nominal Diameter	10 in 25.4 cm	10 in 25.4 cm	12 in 30.48 cm	12 in 30.48 cm
Overall Diameter	11.16 in 28.35 cm	10.85 in 27.5 cm	13.16 in 33.43 cm	12.80 in 32.5 cm
Basket Diameter	9.25 in 23.5 cm	9.25 in 23.5 cm	11.20 in 28.5 cm	11.20 in 28.5 cm
Mounting Depth	5.08 in 12.9 cm	5.08 in 12.9 cm	6.38 in 16.2 cm	6.38 in 16.2 cm
Grill Height	1.43 in 3.64 cm	1.94 in 4.90 cm	1.56 in 4.03 cm	2.12 in 5.40 cm

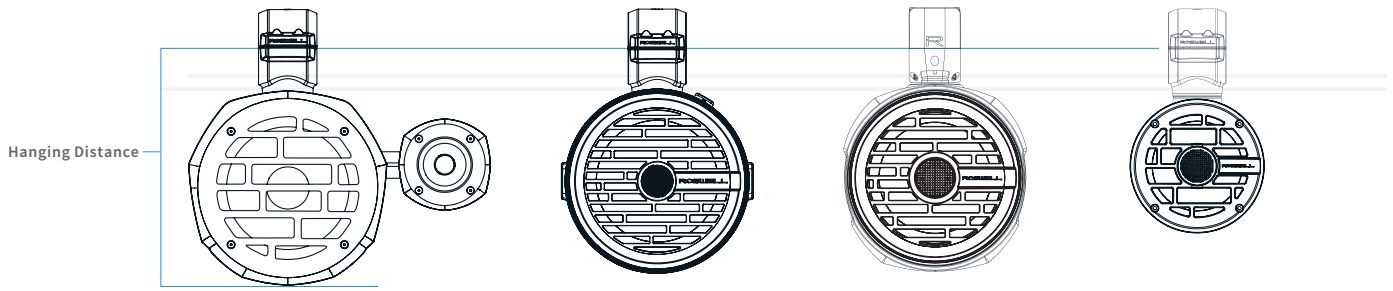

Tower Speakers

	R1 Pro	R1 8"	R1 FireFly	R 6.5"
Nominal Diameter	Woofer: 8 in (20.32 cm) Tweeter: 1 in (2.54 cm)	8 in 20.32 cm	6.5 in 20.35 cm	6.5 in 16.51 cm
Total Width	15.48 in 39.32 cm	9.875 in 25.1 cm	7.11 in 18.06 cm	6.975 in 17.7 cm
Total Depth	13.35 in 33.91 cm	13.575 in 34.5 cm	7.61 in 19.33 cm	8.915 in 22.7 cm
Hanging Distance (From center to lowest point)	12.25 in 31.12 cm	11.50 in 29.21 cm	8.00 in 20.32 cm	9.59 in 24.36 cm

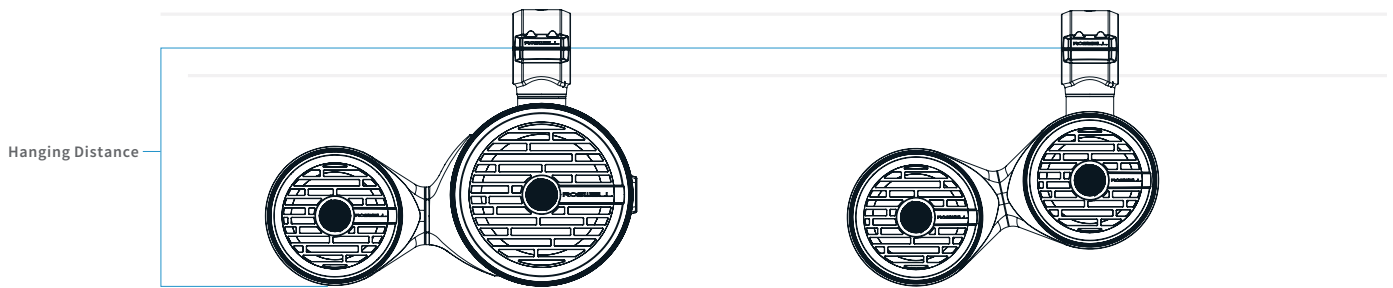

Tower Speakers

	8" x 6.5" R1 Vamp Spin	6.5" x 6.5" R1 Vamp Spin
Nominal Diameter	Mounted Speaker: 8 in (20.32 cm) Spin Speaker: 6.5 in (16.51 cm)	Mounted Speaker: 6.5 in (16.51 cm) Spin Speaker: 6.5 in (16.51 cm)
Total Width	19.30 in 49.0 cm	16.40 in 41.64 cm
Total Depth	13.575 in 34.5 cm	9.0625 in 23.02 cm
Hanging Distance (From center to lowest point)	12.26 in 31.14 cm	12.57 in 31.93 cm

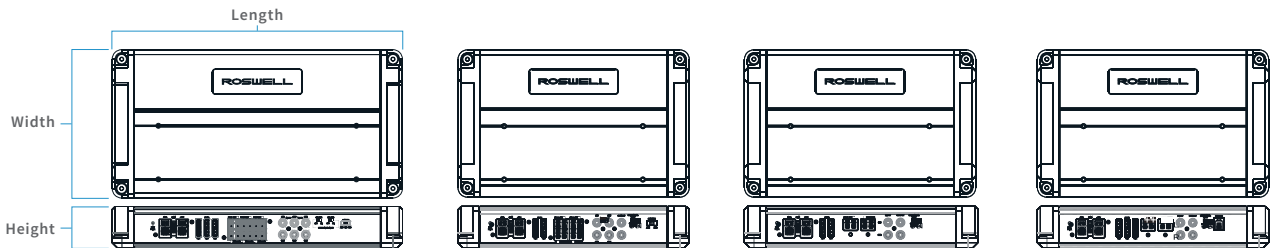

Marine Amplifiers

	R1 950.6	R1 650.4	R1 550.2	R1 1000.1
H x W x L (Inches)	1.90 x 7.0625 x 13.67	1.90 x 7.0625 x 11.125	1.90 x 7.0625 x 11.125	1.90 x 7.0625 x 11.125
H x W x L (Centimeters)	4.83 x 17.94 x 34.74	4.83 x 17.94 x 28.26	4.83 x 17.94 x 28.26	4.83 x 17.94 x 28.26

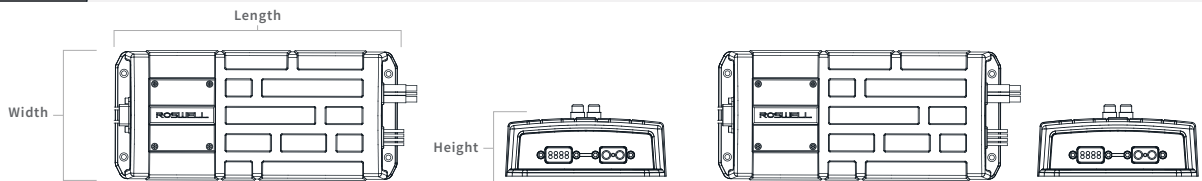

Offroad Amplifiers

	SD 500.1	SD 600.4
H x W x L (Inches)	1.90 x 7.0625 x 11.125	1.90 x 7.0625 x 13.6
H x W x L (Centimeters)	4.83 x 17.94 x 28.26	4.83 x 17.94 x 34.74

AUDIO ACCESSORIES

A NEW LEVEL OF VERSATILITY IN YOUR ARSENAL OF AUDIO

ROSWELL MARINE DIGITAL MEDIA RECEIVER C920-21003 (Digital Media Receiver)

Master your moments with the Roswell Marine **Digital Media Receiver** featuring 4 zone control, bluetooth connectivity, AM/FM Radio, and USB/ AUX inputs. IP66 rated for excellent water resistance, this versatile sound solution commands your arsenal of audio in harsh marine environments.

- Built-in Bluetooth
- 3 in Full Color Display
- RGB Backlit Keypad
- AM/FM | USB/Aux inputs
- 5 Band Equalizer
- 2V RCA Preamp Outputs x 4 zones
- Internal Amplifier 50 Watts/Channel
- RMS Power@4 Ω, 14.4V,<1% T.H.D)
- 4 Zones (3 full range + 1 subzone with adjustable low pass filter)
- IP66 rated for excellent water resistance



ROSWELL MARINE DIGITAL MEDIA WIRED REMOTE C920-21004

- IP66 rated for excellent water resistance
- Backlit LED Display
- Allows source switching and zone control
- Single Wire Hookup for easy installation
- Ideal for mounting near swim platform or any secondary location where stereo control is desired



DIGITAL MEDIA RECEIVER FLUSH MOUNT KIT C910-23655

The Roswell Digital Media Receiver Flush Mount Kit provides a seamless mounting solution to maximize space and functionality with a streamlined, low-profile appearance.



DIGITAL MEDIA RECEIVER COVER C920-21005

Weather-resistant cover provides premium protection for constant clarity, designed exclusively for the Roswell Digital Media Receiver.



CYBOX C920-20130

- IP67 rated for excellent resistance to water and harsh outdoor environments
- Bluetooth 4.1
- AptX HD Streaming
- High resolution sound quality
- Devices memory with auto-connect feature
- Built-in line driver for 2.2V RCA Output
- High voltage to reduce potential noise in the system
- Compact size for convenient mounting



RGB REMOTE AND CONTROLLER C920-1620

- RF Control (requires 2 AAA batteries)
- 15 music-responsive LED modes
- Conformally coated PCB's for marine durability
- Powers up to 430 watts of RGB LED's
- 20 standard LED modes

MARINE AMP WIRING KIT C920-0033



WHAT'S IN THE BOX:

- (1) 1 In 2 Out Fused Distribution Block
- (1) 1 In 2 Out Ground Distribution Block
- (1) ANL Single Fuse Holder
- (2) 4 Gauge Ring Terminal [3/8 in Hole]
- (1) 4 AWG Power Wire [15 Ft]
- (1) 4 AWG Ground Wire [15 Ft]
- (1) 16 Blue Wire [15 Feet]
- (2) RCA Y-Splitter (1F to 2M)
- (2) RCA Y-Splitter (1M to 2F)
- (2) 2-Meter 2-Channel RCA Cable
- (1) 40 Amp Mini ANL Fuse
- (1) 50 Amp Mini ANL Fuse
- (1) 80 Amp Mini ANL Fuse
- (1) 80 Amp ANL Fuse
- (1) 100 Amp ANL Fuse
- (1) 150 Amp ANL Fuse
- (12) 4 in Cable Tie
- (10) #8 x 1/2 in Flat PHIL SS

DUAL ZONE VOLUME CONTROL C920-0300



- Independent volume control for 2 zones
- Simple installation
- Dual logarithmic pots for intuitive response
- Connects with 6 nickel-plated female RCA connectors
- Quad-shielded cable for the ultimate in noise rejection



DISTRIBUTION BLOCK 3-IN-4 OUT

C720-0542 (Fused)
C720-0543 (Ground)

- (3) 1/0 inputs with 4 AWG reducers
- (4) 4 AWG outputs with 8 AWG reducers
- High-impact plastic base and cover
- Fuses sold separately

COMPARTMENT VENT C920-20211



- Made from marine grade materials
- Simple installation



6 PIN BOAT SIDE SPEAKER HARNESS B820-0302

SINGLE FUSE HOLDER C720-0438



- Made from marine grade materials
- Simple installation



4 PIN BOAT SIDE RGB HARNESS- SUBWOOFER B820-23275

DISTRIBUTION BLOCK 1-IN-2 OUT

C720-0540 (Fused)
C720-0541 (Ground)

- (1) 1/0 input with 4 AWG reducer
- (2) 4 AWG outputs with 8 AWG reducers
- High-impact plastic base and cover



TOWER WIRING HARNESS C910-5021

- 8 Insulated color coded 16 gauge
- Copper wires - 15 ft (4.5 m) included
- Full body protection insulation
- Male & female speakON cable connectors
- 316 stainless steel mounting hardware
- Quick connects



RCA CABLES & ADAPTERS

- C920-0325** (5M 6-Channel RCA Cable)
- B720-0320** (.5M 2 Channel RCA Cable)
- B720-0321** (1M 2 Channel RCA Cable)
- B720-0323** (5M 2 Channel RCA Cable)
- B720-0327** (1M to 2F Y Adapter)
- B720-0328** (1F to 2M Y Adapter)
- C720-22100** (8M 2 Channel RCA Cable) - WHITE



- C720-22101** (6M 2 Channel RCA Cable) - WHITE
- C720-22102** (2M 2 Channel RCA Cable) - WHITE
- C720-22103** (1M 2 Channel RCA Cable) - WHITE
- C720-22104** (.5M 2 Channel RCA Cable) - WHITE
- C720-22105** (6M 6 Channel RCA Cable) - WHITE
- C720-22106** (1M TO 2F Y Adapter) - WHITE
- C720-22107** (1M TO 2F Y Adapter) - WHITE

ROSWELL APPAREL

PROJECT YOUR PASSION FOR THE WATER WITH
GEAR FROM ROSWELL MARINE



ROSWELL ICON TEE

Black

C740-21004S C740-21004XL
C740-21004M C740-21004XXL
C740-21004L C740-21004XXXL



ROSWELL SUNSET TEE

Black

C740-21003S C740-21003XL
C740-21003M C740-21003XXL
C740-21003L C740-21003XXXL



ROSWELL BREAKAWAY TEE

Heather Grey Green

C740-21008S C740-21008XL
C740-21008M C740-21008XXL
C740-21008L C740-21008XXXL



ROSWELL WORLDS TEE

Black

C740-21002S C740-21002XL
C740-21002M C740-21002XXL
C740-21002L C740-21002XXXL



ROSWELL BREAKAWAY

Longsleeve • Black

C740-21010S C740-21010XL
C740-21010M C740-21010XXL
C740-21010L C740-21010XXXL



ROSWELL GYOTAKU-HOGFISH

Longsleeve • UV Hooded • Sand

C740-23856S C740-23856XL
C740-23856M C740-23856XXL
C740-23856L C740-23856XXXL



ROSWELL SUNSET

Longsleeve • Light Blue

C740-21009S C740-21009XL
C740-21009M C740-21009XXL
C740-21009L C740-21009XXXL



ROSWELL LET'S GO FISHIN'-GROM TEE

Deep Heather Teal

C740-23855S
C740-23855M
C740-23855L

ROSWELL RETAIL CLOTHING KIT
C740-24400

Hanko Tee (1S,1M,3L, 3XL,1XXL)
Levels Tee (1S,1M,3L, 3XL,1XXL)
Glitch Tee (1S,1M,3L, 3XL,1XXL)
Sunset Long Sleeve UV (1S,1M,3L, 3XL,1XXL)

Palm Ladies Tee (1S,2M,1L,1XL)
Let's Go Fishing Groms Tee (1YS,1YM,2YL,)
Trucker Hat (QTY 4)
R1 Elite Hat (QTY 2)



ROSWELL GLITCH TEE
 Heather Blue Storm
C740-23851S **C740-23851XL**
C740-23851M **C740-23851XXL**
C740-23851L **C740-23851XXXL**



ROSWELL HANKO TEE
 Light Heather
C740-23852S **C740-23852XL**
C740-23852M **C740-23852XXL**
C740-23852L **C740-23852XXXL**



ROSWELL PALM LADIES TEE
 Heather Blue Lagoon
C740-23853S **C740-23853XL**
C740-23853M **C740-23853XXL**
C740-23853L



ROSWELL PEAKS LADIES TEE
 Heather Mauve
C740-23854S **C740-23854XL**
C740-23854M **C740-23854XXL**
C740-23854L



ROSWELL BARREL TEE
 White
C740-21005S **C740-21005XL**
C740-21005M **C740-21005XXL**
C740-21005L **C740-21005XXXL**



ROSWELL R98 TEE
 Black
C740-21007S **C740-21007XL**
C740-21007M **C740-21007XXL**
C740-21007L **C740-21007XXXL**



ROSWELL LEVELS TEE
 Black
C740-21006S **C740-21006XL**
C740-21006M **C740-21006XXL**
C740-21006L **C740-21006XXXL**



ROSWELL TRUCKER HATS
C740-21000 (Blue)
C740-21001 (Black)

TRITON II

STRAPLESS BOARD RACK

C910-21005

The next evolution of the world's most celebrated board rack delivers a progressive step forward with the **Roswell Triton II**. Featuring Roswell's R-FLEX suspension technology, innovative features at every angle deliver the most advanced board storage solution on the water. The R-Flex Talon catchhead conforms to any board edge shape with an autonomous grip to perfectly engage varying surface angles and contours in a way that naturally reacts as pressure is applied for a secure hold.

R-Flex Talon catchhead design conforms to the board edge with an autonomous grip that naturally reacts to any shape as pressure is applied for a secure hold.

Adjustable telescopic arms allow you to securely hold a small child's wakeboard and a large, wakesurfer securely in the same rack.

Integrated stash housing with included custom ripstop rack cover.

All Stainless Steel hardware.

Roswell R-FLEX Suspension Technology featuring two layers of molded board protection.

Fits wakesurfers & wakeboards up to 23" wide and 2.5" thick.

Mounting points deliver vertical and horizontal configuration options.



* Patented

SPECIFICATIONS

Max Board Thickness:	2.5 in 6.35 cm
Min Board Width:	14.0 in 35.56 cm
Max Board Width:	23.0 in 58.42 cm
Mounting Hardware:	316 Stainless Steel
Materials:	6061 aluminum Hard duro TPE

R-FLEX SUSPENSION TECHNOLOGY

Roswell R-Flex Suspension Technology has been integrated into the Triton II delivering an innovative approach to molded board protection that keeps your weapon of choice on cloud 9. Two layers of dampening and deformation contour to any board to hold it snug and suspended from impact.



ELITE II

BOARD RACK

C910-21001

The **Roswell Elite II Board Rack** represents elegance wrapped in innovation that takes our time-tested storage solution to another dimension. Integrating advanced features and functionality with R-Flex suspension technology and an adjustable locking handle, the Elite II delivers a proven platform with a perfect fit for every board.

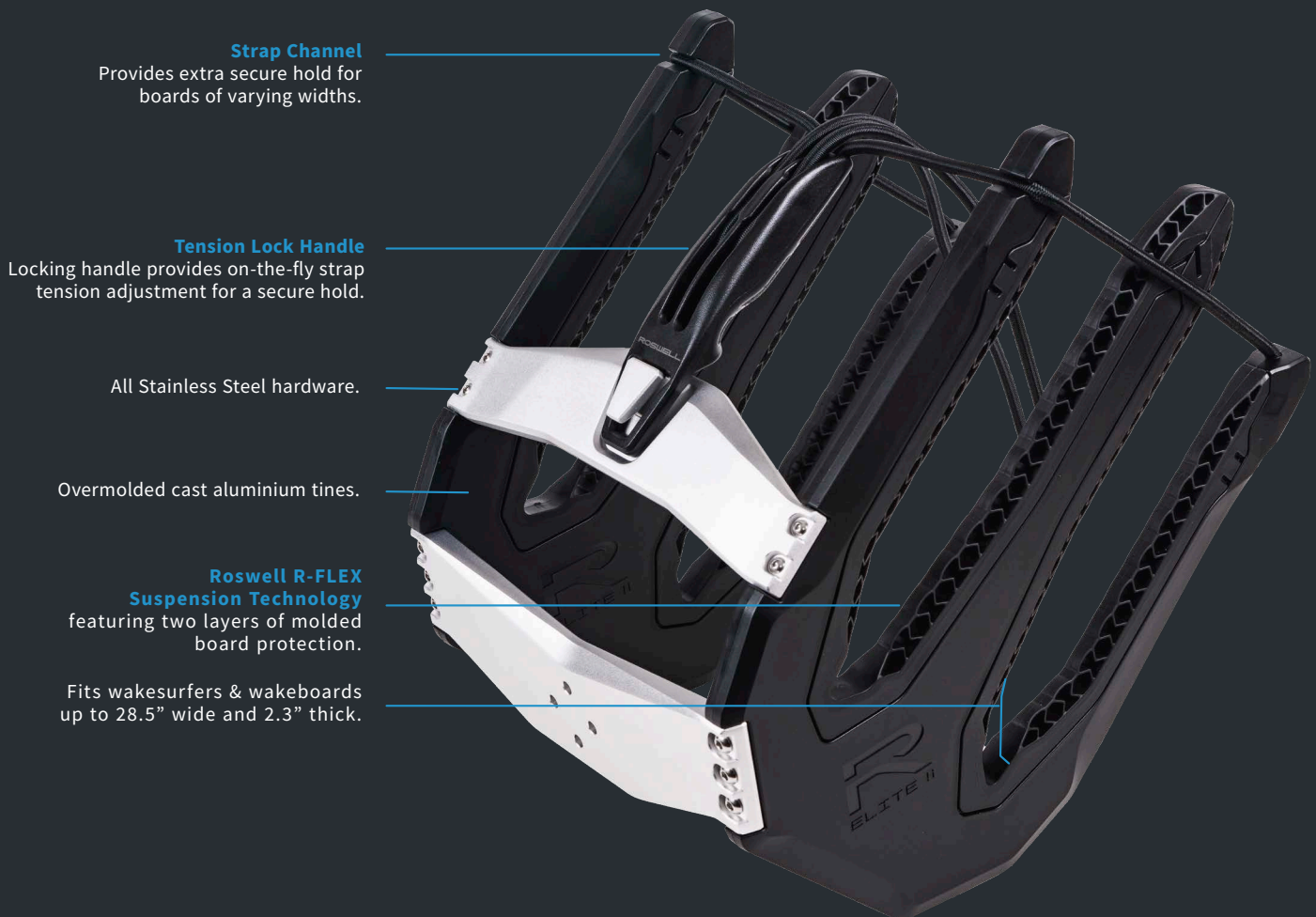

SPECIFICATIONS

Max Board Thickness:	2.3 in 5.84 cm
Min Board Width:	10.0 in 25.54 cm
Max Board Width:	28.5 in 72.4 cm
Mounting Hardware:	316 Stainless Steel
Materials:	6061 aluminum Hard duro TPE Over-molded PP ABS



TRITON STRAPLESS BOARD RACKS

THE MOST ADVANCED BOARD STORAGE SOLUTION ON THE WATER



TRITON II STRAPLESS C910-21005

- **R-Flex Talon catchhead** design conforms to the board edge with an autonomous grip that naturally reacts to any shape as pressure is applied for a secure hold.
- **Adjustable telescopic arms** allow you to securely hold a small child's wakeboard and a large, wakesurfer securely in the same rack.
- **New Integrated stash housing** with included custom ripstop rack cover.
- All Stainless Steel hardware.
- **Roswell R-FLEX Suspension Technology** featuring two layers of molded board protection.
- Fits wakesurfers & wakeboards up to 23" wide and 2.5" thick.
- **New mounting points** deliver vertical and horizontal configuration options.



TRITON STRAPLESS C910-1730

- Billet aluminum tines & crossbars can hold two surfboards, two wakeboards or one of each.
- Vertical board orientation provides improved ergonomics for inserting and removing boards while allowing wet boards to drip outside of your boat.
- 10mm Dual density board protection for your fragile hand-shaped surf boards.
- Compatible with all Roswell after-market towers and swivels.
- Fits wakesurfers & wakeboards up to 23" wide and 2.75" thick.
- Stainless steel hardware.



ELITE SERIES BOARD RACKS

TAKING OUR TIME-TESTED STORAGE SOLUTION TO ANOTHER DIMENSION



ELITE II BOARD RACK
C910-22001

- **Strap Channel** provides extra secure hold for boards of varying widths.
- **Tension Lock Handle** provides on-the-fly strap tension adjustment for a secure hold.
- All Stainless Steel hardware.
- Overmolded cast aluminium tines.
- **Roswell R-FLEX Suspension Technology** featuring two layers of molded board protection.
- Fits wakesurfers & wakeboards up to 28.5" wide and 2.3" thick.



ELITE BOARD RACK
C910-2030 (Complete Rack)
C910-2036 (Tines)

- Holds two wakeboards
- Wakeboard gap: 1.15 in
- Tine spread: 10 in
- **Saltwater friendly**



ELITE DUAL SURF
C910-2032 (Complete Rack)
C910-2038 (Tines)

- Holds two surfboards
- Surfboard gap: 2.75 in
- Tine spread: 10 in
- **Saltwater friendly**



ELITE SURF / WAKE
C910-2031 (Complete Rack)
C910-2037 (Tines)

- Holds one surf & one wakeboard
- Surfboard gap: 2.375 in
- Wakeboard gap: 1.15 in
- Tine spread: 10 in
- **Saltwater friendly**



ELITE SURF XL
C910-2035 (Complete Rack)
C910-2038 (Tines)

- Holds two large style surfboards
- Surfboard gap: 2.75 in
- Tine spread: 29 in
- **Saltwater friendly**



ELITE SKI
C910-2034 (Complete Rack)
*Tines not sold separately

- Holds one pair of water skis
- Water ski gap: 1 in
- Tine spread: 29 in
- Brushed clear coated ski tines
- Machined clear coat



ELITE KNEE / WAKE
C910-2040 (Complete Rack)
C810-0103 (Tines)

- Holds one kneeboard & one wakeboard
- Kneeboard gap: 5 in
- Wakeboard gap: 1.15 in
- Tine spread: 10 in
- Billet aluminum
- **Saltwater friendly**



ELITE KNEEBOARD
C910-2033 (Complete Rack)
C910-2039 (Tines)

- Holds one kneeboard
- Kneeboard gap: 5 in
- Tine spread: 10 in
- Billet aluminum
- **Saltwater friendly**



BUNGEE W/ CLIP
C710-0104



BUNGEE W/ LOOP
C710-0105



ELITE BACKING PLATE
C810-0101

TOWER & RACK ACCESSORIES

UNIVERSAL FIT AND FUNCTION AT ITS FINEST



SI SWIVEL
C910-0062

- 3 Locking positions
- Machined from billet aluminum with a brushed anodized finish
- Easy pull manual locking pin
- Includes adapter plate for Universal Clamp
- Anti-vibration rubber dampener
- To lock or unlock you must compress dampeners
- **Saltwater friendly**



MAG SWIVEL
C910-0049

- 2 Locking positions
- Machined from billet aluminum with a brushed anodized finish
- When used with clamp, Swivel Clamp Adapter required for level swivel motion
- Swivel Clamp Adapter not required with Roswell Tower Mounting Block
- To lock or unlock you must compress dampeners
- **Saltwater friendly**



3 POSITION MAG SWIVEL
C910-24360

- 3 Locking positions
- Machined from billet aluminum with a brushed anodized finish
- When used with clamp, Swivel Clamp Adapter required for level swivel motion
- Swivel Clamp Adapter not required with Roswell Tower Mounting Block
- To lock or unlock you must compress dampeners
- **Saltwater friendly**



360 ADJUSTABLE RACK ADAPTER
C910-20026

- Includes: 1x large and 1x small plastic insert
- machined billett aluminum with a sandblasted anodized finish
- 360° of rotational mounting positions
- Fits round & square tubing sizes of 1 in to 2.5 in
- Compatible with fixed racks only
- **Saltwater friendly**



MC ZFT2 RACK ADAPTER
C910-21000

- Compatible with 2018-2021 ZFT2 tower
- Machined from billet aluminum with a brushed clear anodized finish
- Compatible with Roswell swivels and board racks



BOARD RACK ADAPTERS

- **C810-0106** (Supra FX One)
- **C810-0102** (G3-G4 Malibu/Axis)
- **C810-23701** (G5-GX+ Malibu/Axis W/Swivel port)
- **C810-23702** (G5-GX+ Malibu/Axis W/Swivel strbd)
- **C810-0100** (Triton Fixed Rack Adapter)
- **C810-0108** (Moomba v2 Fixed Rack Adapter)
- Machined from billet aluminum with a brushed clear anodized finish
- Compatible with Roswell swivels and board racks
- **Saltwater friendly**



FIXED TRITON RACK ADAPTER
C810-0100

- Machined from billet aluminum with a sandblast anodized finish
- Compatible with all Roswell board racks
- Most cost effective way to mount Triton rack to many Roswell towers
- **Saltwater friendly**



CHAPARRAL QR BOARD RACK ADAPTER
C927-1802

- Compatible with EFX & EFX2 Towers
- Machined from billet aluminum with a brushed clear anodized finish
- Compatible with Roswell swivels and board racks



4.25" RACK SPACER W/HARDWARE
C817-20448

- Provides additional clearance between Mag Swivel and Board Rack

TOWER & RACK ACCESSORIES

UNIVERSAL FIT AND FUNCTION AT ITS FINEST



SWIVEL CLAMP ADAPTER
C910-0053

- Machined from billet aluminum with a brushed anodized finish
- Easily level your clamped swivel board rack
- Accurate degrees of rotation
- Compatible with Roswell clamp and swivels
- **Saltwater friendly**



ROTATIONAL SPEAKER ADAPTER
C820-0900

- Machined from billet aluminum with a sandblast anodized finish
- Mount speakers at desired angle
- Low profile mounting hardware included
- Ask your Authorized Roswell Dealer about adapter compatibility



FIXED SPEAKER ADAPTER

C820-0901 (Nautique G-Series)
C820-0902 (Nautique GS-Series)
C910-20144 (Supreme F-Series)

- Machined from billet aluminum with a brushed clear anodized finish
- **Saltwater friendly**



3" UNIVERSAL CLAMP
C910-0047

- **Includes:** 1.9 in, 2.375 in, 3 in plastic inserts
- **Available for purchase:** 2 in, 2.25 in, 2.5 in, 2.85 in plastic inserts
- Machined from billet aluminum with a sandblasted clear anodized finish
- Compatible with all Roswell Products
- **Saltwater friendly**



UNIVERSAL CLAMP
C910-0023

- **Includes:** 1.9 in, 2.375 in plastic inserts
- **Available for purchase:** 1.6 in, 2.0 in, 2.5 in plastic inserts
- Cast aluminum with a brushed clear coated finish
- Compatible with most Roswell products



360° 3" UNIVERSAL CLAMP
C920-0747

- **Includes:** 1.9 in, 2.375 in, 3 in plastic inserts
- **Available for purchase:** 2 in, 2.25 in, 2.5 in, 2.85 in plastic inserts
- Machined from billet aluminum with a sandblasted clear anodized finish
- Compatible with most Roswell Tower Speakers
- External set screws allow for 360° rotational mounting positions
- **Saltwater friendly**



360 FLAT MOUNT SPEAKER ADAPTOR (FIREFLY)
C920-20025

- Provides flat surface mounting solution for Firefly Speakers



3" CLAMP INSERT

C910-0050 (1.9")
C910-0060 (2")
C910-0055 (2.25")
B910-0401 (2.375")
C910-0051 (2.5")
B910-0403 (3")
C910-0056 (2.85")



UNIVERSAL CLAMP INSERT

C910-0035 (1.6")
B710-0403 (1.9")
C910-0036 (2")
B710-0404 (2.375")
C910-0037 (2.5")

ELEVATE YOUR EXPERIENCE

ROSWELL TOWERS

A history that began with a new approach to elevated tow points has transformed into revolutionary technology and manufacturing processes to produce the world's best towers. Roswell has become a stamp of excellence and a proven solution for premium marine products featured on boats that set the highest standard in the industry. Each product shares a lineage of industry-leading innovation, trusted to deliver the very best experiences on the water for our customers.



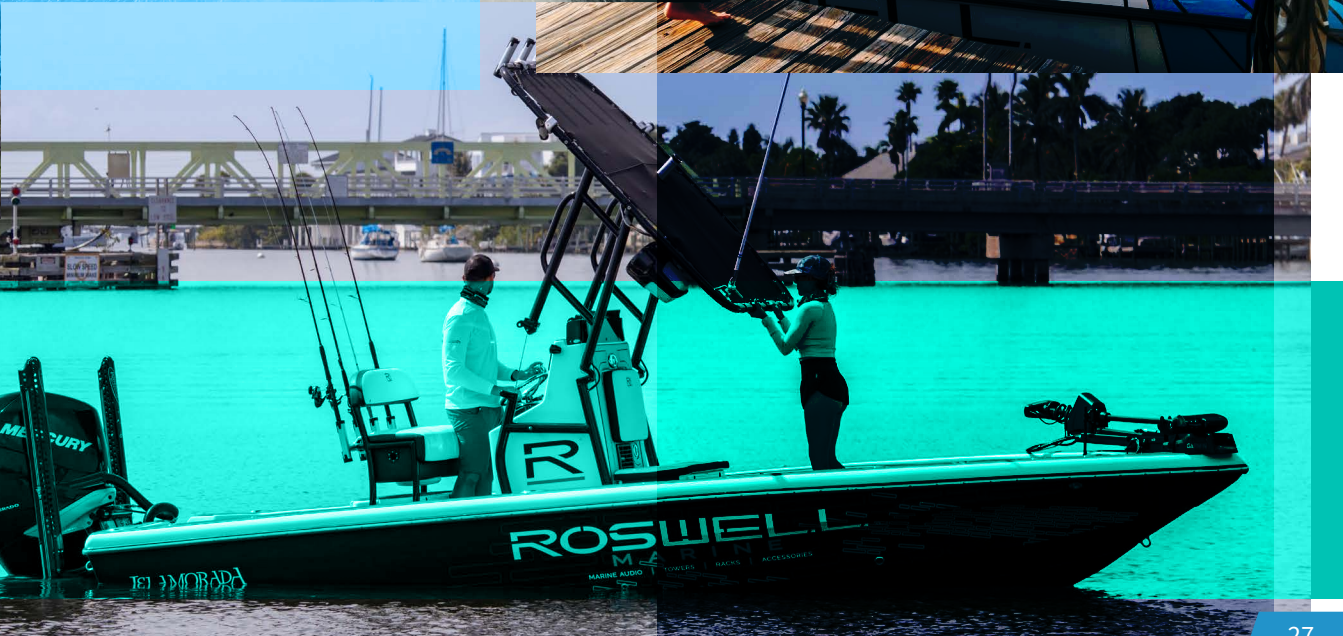
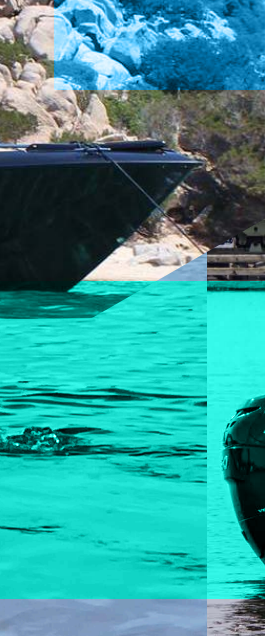

AVIATOR PRO



FEATURES

- Designed to work with Aviator Soft Top
- Roswell USCG approved Anchor Light included
- Pre-wired for lights and speakers
- Forward folding universal tower

Adjustable center section with brushed anodized finish.

Built-in mounting blocks for swivel board racks and fixed racks.

Patented cam latch & weight-assist system.

OEM style foot mount

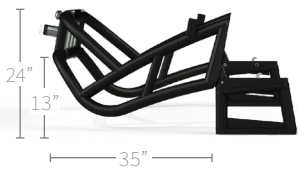

SPECIFICATIONS:

Mounting Hardware:	316 stainless steel
Tower Tubing Size:	2.37 in 6.03 cm
Center Section Tubing Size:	3 in 7.62 cm
Narrow Tower Width:	80 - 92 in 203.2 - 233.68 cm
Wide Tower Width:	86 - 104 in 218.44 - 264.16 cm
Tower Materials:	T5 6061 aluminum SCHED 40

RISER BLOCKS

Aviator Pro 4.5" Riser Black
C710-0094
 Aviator Pro 4.5" Riser White
C710-0095

AVAILABLE OPTIONS:

C910-3116 (Narrow - White)
C910-3117 (Narrow - Black)
C910-3112 (Wide - White)
C910-3113 (Wide - Black)



AVIATOR



FEATURES

- Designed to work with Aviator Soft Top
- Universal low-profile mounting system
- Pre-wired for lights and speakers
- Forward folding universal tower

Brushed anodized adjustable center section with mounting location for Roswell Anchor Light

Built-in mounting blocks for swivel board racks and fixed racks

Patented cam latch & weight-assist system

Billet aluminum feet and 316 stainless steel mounting hardware

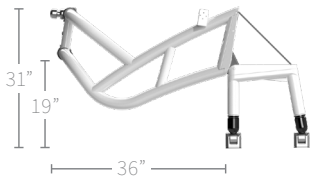

SPECIFICATIONS:

Mounting Hardware:	316 stainless steel
Tower Tubing Size:	2.37 in 6.03 cm
Center Section Tubing Size:	3 in 7.62 cm
Narrow Tower Width:	80 - 92 in 203.2 - 233.68 cm
Wide Tower Width:	86 - 104 in 218.44 - 264.16 cm
Tower Materials:	T5 6061 aluminum SCHED 40

AVAILABLE OPTIONS:

C910-3150	(Narrow - White)
C910-3151	(Narrow - Black)
C910-3108	(Wide - White)
C910-3109	(Wide - Black)



SOFT TOP BIMINI

C910-2025	(Narrow)
C910-2026	(Wide)



- 69 in coverage length
- Brushed anodized aluminum frame
- Easily collapsible and stored on tower
- 316 stainless steel hardware
- Storage boot included
- Narrow bimini works with tower widths 80 in - 90 in
- Wide bimini works with tower widths 90 in - 104 in
- Compatible with Aviator Tower



FEATURES

- Designed to work with Sun Top Bimini
- Modular forward folding universal tower
- Pull strings for routing audio/12V wiring
- Simplified low-profile mounting system
- Saltwater friendly (Brushed Anodized)

Built-in mounting blocks for (1) pair of R 6.5"

Adjustable center section with mounting location for Roswell Anchor Light

Built-in mounting blocks for swivel or fixed board racks

Patented cam latch system

Billet aluminum feet and 316 stainless steel mounting hardware

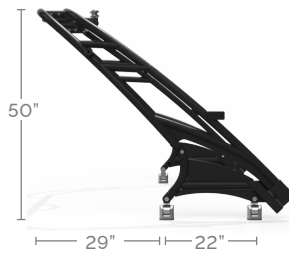
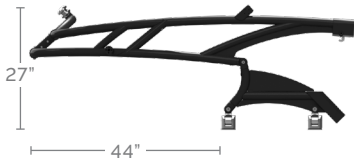

SPECIFICATIONS:

Mounting Hardware:	316 stainless steel
Tower Tubing Size:	1.9 in 4.83 cm
Center Section Tubing Size:	2.37 in 6.03 cm
Narrow Tower Width:	78 - 92 in 198.12 - 233.68 cm
Wide Tower Width:	90 - 104 in 228.6 - 264.16 cm
Tower Materials:	T5 6061 aluminum SCHED 40

AVAILABLE OPTIONS:

C910-3120	(Narrow - Brushed/Anodized)
C910-3121	(Narrow - Black)
C910-3130	(Wide - Brushed/Anodized)
C910-3131	(Wide - Black)



SUN TOP TOP BIMINI

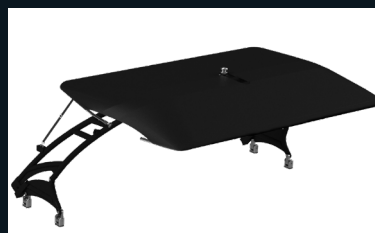

- C910-2027** (Narrow)
- C910-2028** (Wide)

- 64 in coverage length
- Brushed anodized aluminum frame
- Easily collapsible and stored on tower
- 316 stainless hardware
- Built-in storage boot
- Narrow bimini works with tower widths 78 in - 92 in
- Wide bimini works with tower widths 90 in - 104 in
- Compatible with CAM RT and AVX XL towers only



FEATURES

- Designed to work with Area 53 Bimini
- All new super lightweight design (approximately 50 lbs)
- Pull strings for routing audio/12V wiring
- Top mount or side mount

Adjustable center section with mounting tab for Roswell Anchor Light

Built-in mounting blocks for fixed board racks

Optionally folds forward or backwards

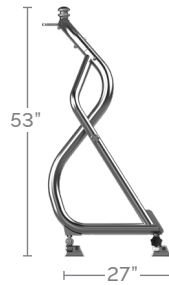
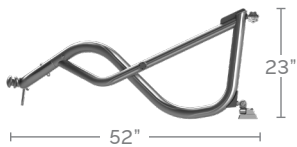

SPECIFICATIONS:

Mounting Hardware:	316 stainless steel
Tower Tubing Size:	2.37 in 6.03 cm
Center Section Tubing Size:	3 in 7.62 cm
Narrow Tower Width:	76 - 102 in 193.04 - 259.08 cm
Tower Materials:	T5 6061 aluminum SCHED 40

AVAILABLE OPTIONS:

- C910-1700** (Brushed/Anodized)
- C910-1701** (Black)



AREA 53 BIMINI



- C910-1740** (Narrow)
- C910-1741** (Wide)

- 50in coverage length
- Brushed anodized aluminum frame
- Easily collapsible and stored on tower
- 316 stainless steel hardware
- Storage boot included
- Narrow bimini works with tower widths 76 in - 88 in
- Wide bimini works with tower widths 88 in - 102 in



Roswell Marine has introduced the world's first weight-assisted universal folding T-Top for center console boats with the all-new **Roswell UNI-T**. This unique design is fully adjustable to fit a wide variety of consoles, maximizing space and function with the ability to easily fold forward to a lowered height of 60" from the deck. Roswell's patented weight-assist technology is integrated to give users the ability to easily fold the UNI-T for overhead clearance during storage or when passing underneath bridges. Created for maximum compatibility.

Standard Bimini Coverage:

6ft 7in | 200.66 cm front to back
 5ft 4in | 162.56 cm side to side
 34.8 ft² | 224.52 cm²

Overall Height:
 75 in | 190.5 cm

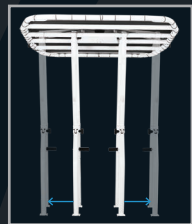

Adjustable Width Range:
 18 - 50 in | 45.72 - 127 cm

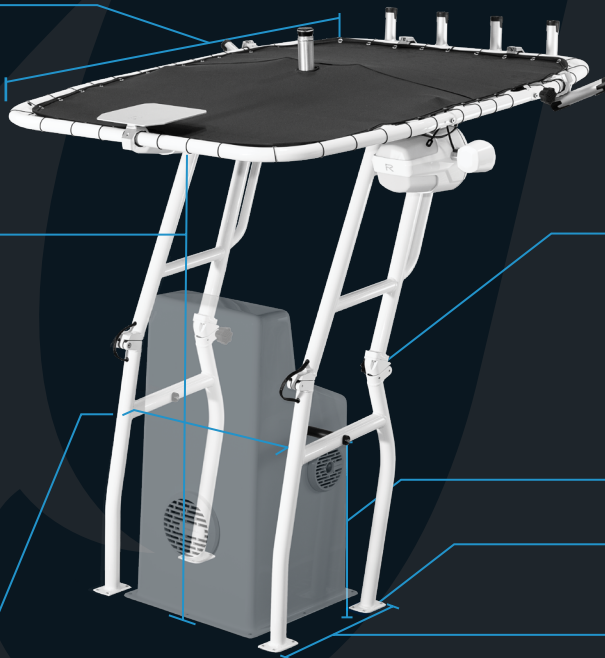

Lowered height (to deck):
 60 in | 152.4 cm

Center Mount Station Height:
 29.5 in | 74.93 cm

Foot Size:
 3.625 in x 5.75 in
 9.21 cm x 14.61 cm

Foot Spread (Outside):
 25.425 in | 64.57 cm

AVAILABLE OPTIONS:

- C910-20351** Uni-T Standard White Powder Coat (w/Canvas)
- C910-20350** Uni-T Standard Black Powder Coat (w/Canvas)
- C910-20352*** Uni-T Standard Chem Film (w/Canvas)

*** Chem Film treated UNI-T options available in custom colors.**
 Roswell Marine's six-stage Chem Film immersion treatment process passivates aluminum parts for advanced corrosion protection and paint adhesion.

FEATURES:

- **Weight assisted folding** to a lowered height of 60 in | 152.4 cm from deck
- **Corner plates** for lights & antennas
- **Compact leg design** to keep in tight to the center console
- **Adjustable side section width range:** 18 in - 50 in | 45.72 cm - 127 cm
- **Simple to install**, universal console mounting bar
- **Foldable Bimini**
- **Pre-run wiring pull cables**

SPECIFICATIONS:

Mounting Hardware:	316 Stainless Steel
Tower Materials:	T5 6061 aluminum SCHED 40
Vertical Tubing Size:	2.375 in 6.03 cm
Horizontal Tubing Size:	1.9 in 4.83 cm
Handle Tubing Size:	1.5 in 3.81 cm



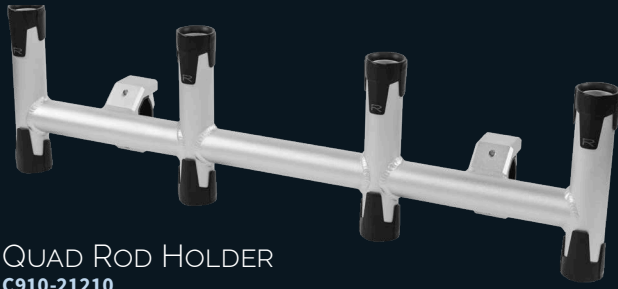

QUAD ROD HOLDER C910-21210

The Roswell Marine Quad Rod Holder delivers a stylish solution to fishing rod storage with bolt-on versatility and a visual signature that complements any boat. Adjustable rack clamps can be configured for round and square tubing sizes allowing you to mount it to your t-top, leaning post, and more.

FEATURES:

- **Adjustable Rack Clamps** - Securely attaches to 1 in - 2.5 in round tube or 1 in - 1.75 in square tube
- **Plastic Guide Caps** - Provides smooth, non-damaging surface for rod handle and reel foot
- **Extreme Saltwater and UV Resistance**



SPECIFICATIONS:

Tube Height:	9 in 22.8 cm
Tube ID:	1.61 in 4.1 cm
Spacing Between Holders:	9 in 22.9 cm
Overall Width:	4.75 in 88.3 cm
Clamp Tube Compatibility:	1 in - 2.5 in round tube or 1 in - 1.75 in square tube

UNI-T RIGGING PLATE C910-21250

The Roswell Rigging Plate provides the perfect platform to mount outriggers, radar units and antennas on top of the UNI-T.



- Fits round & square tubing sizes of 1 in to 2.5 in
- Includes: 1x large and 1x small plastic insert
- Saltwater Friendly

12 in x 12 in Surface Area
For mounting accessories

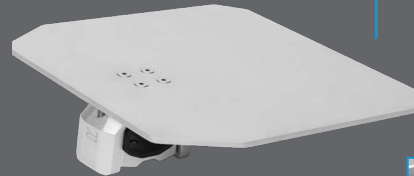

Adjustable
Rack Clamp

SINGLE ROD HOLDER C910-21200

The Roswell Marine Quad Rod Holder delivers a stylish solution to fishing rod storage with bolt-on versatility and a visual signature that complements any boat. Adjustable rack clamps can be configured for round and square tubing sizes allowing you to mount it to your t-top, leaning post, and more.

FEATURES:

- **Two Clamp Positions** - Easily attach the adjustable rack clamp to the upper or lower point on the rod holder for flush or extended mounting configuration options
- **Flower Cut Angle Adjustment** - Allows the rod holder to be rotated into 8 different positions
- **Adjustable Rack Clamps** - Securely attaches to 1 in - 2.5 in round tube or 1 in - 1.75 in square tube
- **Plastic Guide Caps** - Provide smooth, non-damaging surface for rod handle and reel foot
- **Extreme Saltwater and UV Resistance**

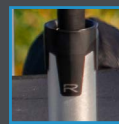

Plastic Guide
Caps



Adjustable
Rack Clamps



SPECIFICATIONS:

Tube Height:	9 in 22.8 cm
Tube ID:	1.61 in 4.1 cm
Overall Width:	2.2 in 5.6 cm
Clamp Tube Compatibility:	1 in - 2.5 in round tube or 1 in - 1.75 in square tube

BOAT ACCESSORIES

RIDE SEAT SUSPENSION SYSTEM

C910-23704 (White)

C910-23705 (Black)



FEATURES:

- **Compatible with select Llebroc & Springfield** seat mounting systems
- **Approximate Compression Range** 0-1.5 in
- **Versatile, Low-Profile Design** to Fit a Wide Range of Boats
- **Hinged Aluminum Wishbone Frame** with Spring-Loaded **R-Flex Suspension Block**
- **Chem Film Treated Aluminum Construction** for Excellent Corrosion Resistance
- CRE and PPG **High Quality Paint**
- **Stainless Steel Hardware**
- **Simple Installation**
- Patent-Pending

DIMENSIONS

Height: 3.80 in | 9.65 cm
Length: 8.50 in | 21.59 cm
Width: 9.25 in | 23.50 cm

BOARDING STEPS

C910-22360 (Right Hand Full Assembly)

C910-22362 (Left Hand Full Assembly)



FEATURES:

- **Adjustable Quick-Release Legs** - Configurable for various gunwale heights and angles
- **Adjustable Quick-Release Handle** - Provides adjustable grip for increased boarding stability
- **Gunwale Grip Mounting Point** - Provides secure placement at any rod holder location
- **Collapsible Design** - Folds flat for easy storage
- **Extreme Saltwater and UV resistance**

DIMENSIONS:

Expanded

Height: 69.25 in | 176 cm
Width: 20.19 in | 51.3 cm
Depth: 34.62 in | 88 cm

Collapsed

Height: 41.25 in | 105 cm
Width: 20.19 in | 51 cm
Depth: 5 in | 13 cm

Weight

26 Lbs | 11.8 kg

NEST FENDER

C910-24075

FEATURES:

- **Grey EVA Closed Cell Foam**
- **Form Fit Design** to maximize stability and contact surface area
- **Nested Stacking** for compact storage
- **Premium Roswell badging**
- **Reinforced Line Guide**

DIMENSIONS:

Height: 24.85 in | 63.119 cm
Width: 10.33 in | 26.2382 cm
Depth: 6 in | 15.24 cm



BOAT ACCESSORIES

BOSUN'S BREW CLEANING KIT C940-23782

The Bosun's Brew Cleaning Kit features an expertly crafted collection of marine-grade formulas to ensure your vessel stays pristine and protected. Packaged in a custom aluminum carry case with an EVA base, this kit includes premium on-board boat care essentials created for life on the water.

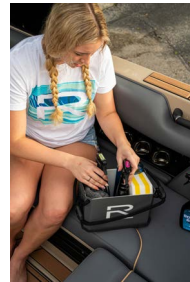

BOSUN'S BREW EPIC ERASER C740-23793

- Instantly erases dirt, grime, scuff marks and streaks
- Removes scuffs and stains from vinyl, plastic and fiberglass
- For home, auto, RV, boat and more



BOSUN'S BREW INTERIOR CLEANER C740-23791

Bosun's Brew Vinyl Cleaner is a powerful formula created to eliminate the toughest dirt, grime and stains from your vinyl, plastic, rubber and leather surfaces. Use on boat upholstery, interior & exterior, trim, foul weather gear, outdoor cushions, canopies and more.



BOSUN'S BREW WATER- REPELLING GLASS CLEANER C740-23790

Bosun's Brew Glass Cleaner is specially formulated to enhance visibility with a streak free, water repelling finish. Removes residue and bugs from glass, plexiglass, chrome and more while leaving a protective coating that causes water to bead up and roll away with a single application. Exterior Use Only.



BOSUN'S BREW HULL | DECK CLEANER C740-23789

Bosun's Brew Hull | Deck Surface Shield quickly cleans, adds shine and protects all deck and hull surfaces. PTFE polymers bond to surfaces to enhance color and provide a protective barrier to prevent UV damage. Scented with fresh berry notes.



BOSUN'S BREW BOAT WASH & WAX C740-23792

Bosun's Brew Boat Wash & Wax is a biodegradable, super-concentrated formula packed with the refreshing scent of pine. Special cleaning agents work with marine-grade polymers to eliminate the toughest dirt and grime while adding shine and UV protection in one step. Safe for all fiberglass, vinyl, painted surfaces, rubber, plastic, aluminum, teak, enamel, plexiglass, polyurethane, and varnished surfaces.

BOAT ACCESSORIES



SEAHORSE HANGER
C910-0901

- Fits 1.9 in - 2.25 in & 2.375 in - 3 in tubing sizes
- Easy to snap on and remove from your tower
- Rubber grips prevent tower damage and provide grip
- You can hang anything you can hook to it weighing up to 10lbs
- Floats so you won't lose it in the water



ROSWELL ROTO COOLER
C940-23590

- 45 quart/42.5 liter capacity
- Aluminum Extendable Handle
- Hinged High-Strength Latches
- Fits 40+ Cans (with no ice added)
- 3" x 8" Wheels
- Tie Down Slats



ROPE HOOKS
C910-0019

- Neatly stores your tow rope
- Rotates for ease of rope removal
- Lock rope in place to prevent unraveling
- Fits tubing sizes from 1.9 in to 3 in
- No need to drill holes



FLAG HOLDER
C910-24200

- Precision-engineered to accommodate 0.5 in rider down flag pole
- Easily attaches to any Roswell Board Rack mounting block
- Extended housing to accommodate up to 1.5 in diameter flag pole

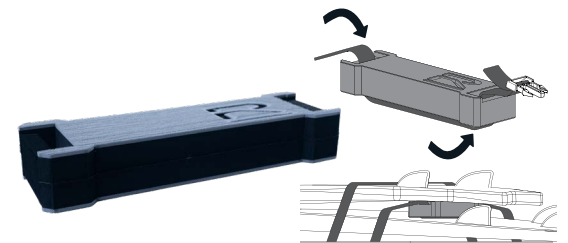

DUAL SURF POCKET SPACER BLOCK
C910-23753

- For Use on Dual Surf Pocket
- Protects and secures stacked boards
- Non-absorbent EPA foam



ANCHOR LIGHT
C910-0018

- Brushed clear anodized finish
- All-round LED light
- Mounts easily to tower
- Fits 1.9 in & 2.325 in tubing
- USCG approved

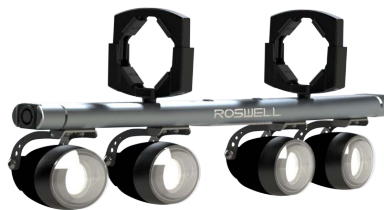

NIGHTVISION 4
C910-1722

- 4x articulating 3W HP LED lamps
- Blue lens LED courtesy light
- Polycarbonate LED lenses



STEP PAD
C910-0052 (Grey)
C910-0054 (Brown)

- Durable and shock absorbent
- 16 in length x 3 in width
- Provides added traction
- SeaDek® non-absorbent EVA foam

MIRRORS



DUAL 360° ROTATION POINTS

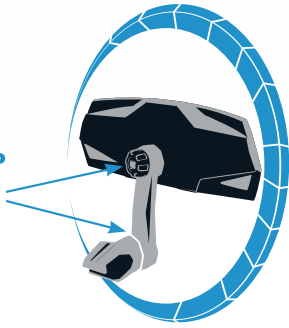

ROSWELL REFLECT 360 UNIVERSAL MIRROR C910-21129

- **R-Flex Inserts** help to provide protection and extra grip to the windshield
- **R-Flex Inserts** protect and conform to the different header profiles
- **New** overmolded soft-touch mirror knob
- **Tactile Feedback** when positioning
- **Dual 360°** rotation points
- **Molded** hand grips
- **144°** HD panoramic reflection
- **Extreme saltwater and UV resistance**

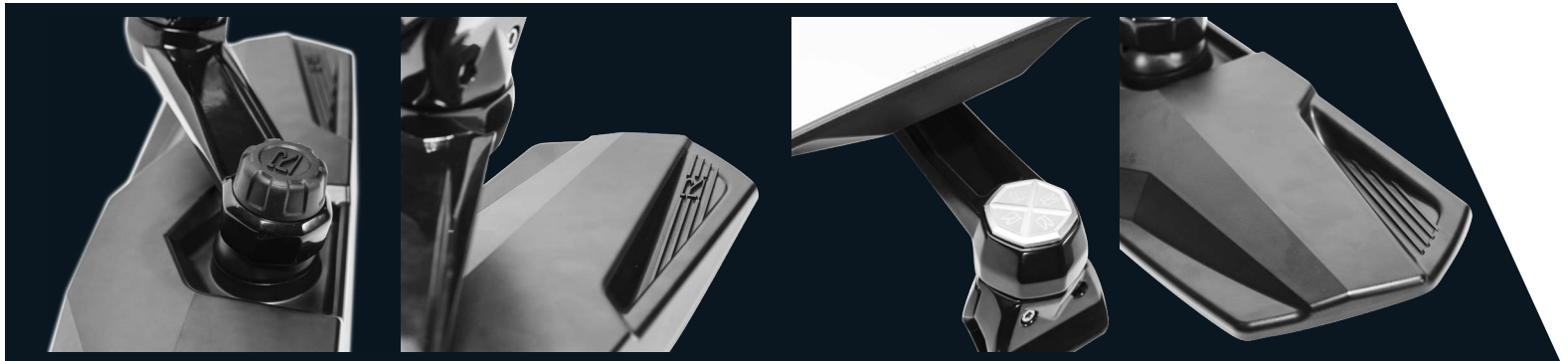

ROSWELL MIRROR & MOUNT

- **C910-0061** (Mirror/Mount Combo)
- **C910-0044** (Mirror Only)
- **C910-0059** (Mount Only)

- Asymmetrical design with wide viewing angle
- Thumb grip area for mirror adjustment
- Large ergonomic handle to secure mirror in desired position
- Adjustable mounting clamp fits most windshield headers
- Soft rubber padding prevents damage to windshield
- Articulating mirror arm for optimal positioning
- Quick fold for use with boat cover



ELITE MIRROR ARM

C910-0038

- Dual articulation points
- Roswell machined logo
- Three way adjustable swivel
- Brushed and clear coated aluminum finish
- Includes: 1.9 in and 2.375 in clamp inserts
- Available for purchase: 1.6 in, 2.0 in, & 2.5 in clamp inserts

ROSWELL

RIDERS

RUSTY MALIOSKI

SEAN SILVEIRA

GRANT KORGAN

HUDSON HAYNIE

CORY TEUNISSEN



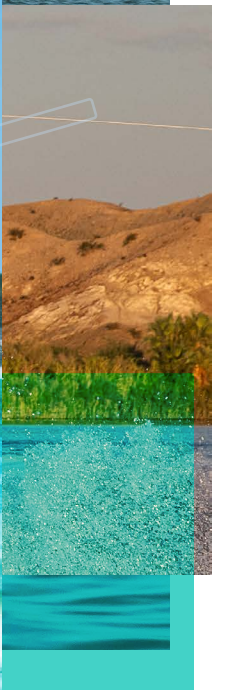

ROSWELL

MARINE

roswellmarine.com

Committed to excellence in manufacturing for 25 years

The content in this catalog is current as from the publication date and supersedes all previous content for Roswell products. Every effort has been made to ensure the information in it is correct at the time of going to press; however, due to a policy of continuous development, Roswell MARINE reserves the right to modify any content or technical data without notice. Roswell and the Roswell logos are trademarks of Roswell U.S. LLC d/b/a Roswell MARINE. All other trademarks and trade names are the property of their respective holders. No part of this website or the Roswell trademarks may be reproduced in any form or by any means without the prior written permission of Roswell MARINE.



@ ROSWELL MARINE

ROSWELL U.S.A.
2900 Murrell Road
Rockledge, FL 32955 | Tel. (321) 638-1331

ROSWELL CANADA
11208 261st
Acheson, Alberta T7X 6C7 | Tel. (780) 962-0868

ROSWELL AUSTRALIA
6 Toorak Avenue
Taren Point, NSW 2299 AU | Tel. +61-(2)-9525-1223

ROSWELL EUROPE
Lorentzstraat 14 3846 AX Harderwijk The Netherlands
info@roswellmarine.eu | +31 (0)341 433684

EMAIL
info@roswellmarine.com